

# COMPETENCE 312 B

Build-in Multifunction Single Oven

**AEG**

Instruction Book

**AUS  
ERFAHRUNG  
GUT**

## Congratulations!

You are now the owner of a high quality, efficient and exciting cooking appliance.

From now on cooking should not only be made easier, but we believe you will find the new cooker a joy to use. The cooker will provide you with very good cooking results, is easy to use and maintain, if you take a little time to study the information contained in the instruction booklet, as well as in the lead-in pages of the accompanying recipe book. With just a little care the appliance will retain its superb appearance for many years to come.

**You must read these instructions prior to using the appliance and retain them for future reference.**



Printed on recycled paper.  
AEG – putting words into action.

# Contents

<b>Safety instructions</b>	
For the installer	4
For the user	4
<b>Appliance description</b>	
Features	5
<b>First use</b>	
Operating the controls	6
Precognising the oven	6
<b>Operating the digital timer</b>	7/8
<b>How to use the oven</b>	
General	9
Fat filter	10
How to use the cooking functions for the oven	11
Switching on and off	11
Baking	11/12
Roasting and stewing	12-14
Grilling	15/16
Specialised applications of the hot air oven	
- Menu cooking	17
- Defrosting	18
- Bottling	19
<b>Cleaning and care</b>	
Oven	20-24
<b>Optional extras</b>	25/26
<b>What to do if ...</b>	27
<b>Service</b>	28

## Safety instructions

### For the installer

The safety requirements state that the following information be given:

When installing cooking appliances into kitchen furniture the enclosed installation instructions must be strictly adhered to.

### For the user

- **When you use the appliance to prepare your food, the oven doors and cooking plates become hot. Therefore keep small children well away from the appliance. This especially applies when you are grilling or pyrolytically cleaning the oven (where applicable).**
- Overheated fat and cooking oil may ignite. Prepare foods requiring fat or oil (chips) only under constant supervision.
- Do not use the appliance to heat your room.
- Take care when using small electrical appliances near the cooker. Connection leads should not come in contact with hot hobs/cooking zones or get trapped in the hot oven door.
- Do not line the oven base with aluminium foil or place any other cooking utensil on the base, as this will trap heat resulting in damage to the enamel interior. This invalidates the warranty.
- The cooling fan, where featured in ovens and cookers, can continue to run although all oven switches are turned off. It will switch itself off automatically. The cooling fan can also come on automatically although the oven is switched off if the residual heat in the oven is too high. The fan switches itself off automatically.
- The vitreous enamel in your oven is very durable. However vitreous enamel is adversely affected by fruit acids (rhubarb, lemon, etc.) and tea which will discolour and dull the enamel. The performance of the oven is not affected. To prevent spillage of the above coming in contact with the enamel, place the cooking container on a baking sheet.
- **Do not place the grill/meat pan on the cooking plate to make gravy.** The direct heat will weaken the pan base resulting in warping and twisting of the pan when next used as a meat or grill pan.
- The appliance complies with radio interference suppression specifications EN 55014 (previously EEC Directive 87/308) and as appropriate with EN 60555 relating to the Retroactive Effect of the Mains Supply.

## Appliance description

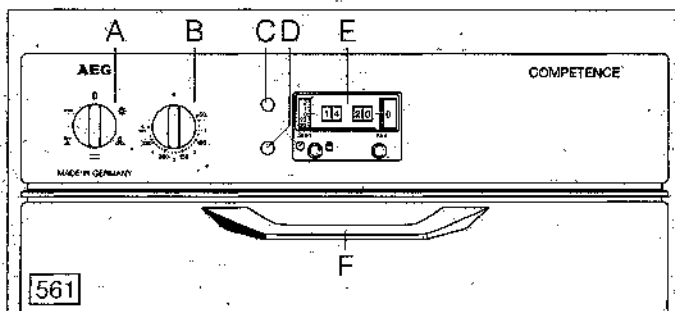

**A** Cooking method selector for:



**Hot air cooking**



**Rotitherm roasting/grilling**



**Grilling**

**B** Temperature selector

**C** Thermostat control light (red) is on when the oven is heating

**D** Pilot light (yellow) is on when the appliance is switched on

**E** Digital clock with minute minder and auto-timer

**F** Handle to open the oven door

## Features

## First use

### Operating the control knobs

The control knob (A) can be turned clockwise or anti-clockwise to any position.

However, the oven temperature control knob (B) must be turned clockwise to set and anti-clockwise to turn off.

### Pre-cleaning the oven

Before using the oven for the first time, clean all accessories (shelf supports, wire shelves and pans) with warm water and washing-up liquid. Then switch the oven to the hot air cooking method and select the highest temperature and leave the oven on for at least one hour with the oven door closed.

During this period there is an unavoidable odour which is not harmful to your health. **We recommend that the room is well ventilated for your convenience.**

When the oven has cooled down, clean any parts not lined with catalytic self-cleaning panels with water and washing-up liquid.

## Operating the digital timer

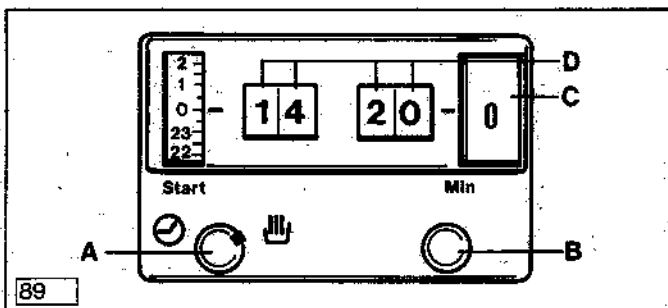

– Pull knob B and release, the digits rotate in display D of the clock.

– When the correct time appears in display D, push in knob B.

**For manual operation of the oven the change-over switch A has to face the hand symbol .**

– Select the cooking option and the temperature you want.

– Press knob B and hold depressed until the required time shows next to the marker in display C. Release knob B and the time is counting down in display C.

When the selected time has elapsed you will hear an audible signal which will switch off automatically after approximately 2 minutes. To switch this off manually press knob B until "0" shows against the marker in display C.

**Setting the time of day**

**You should also be aware of the following:**

**Setting the minute minder**

**You should also be aware of the following:**

**How to programme the oven to switch off automatically**

**You should also be aware of the following:**

**Automatic switch-on and -off of the oven**

**You should also be aware of the following**

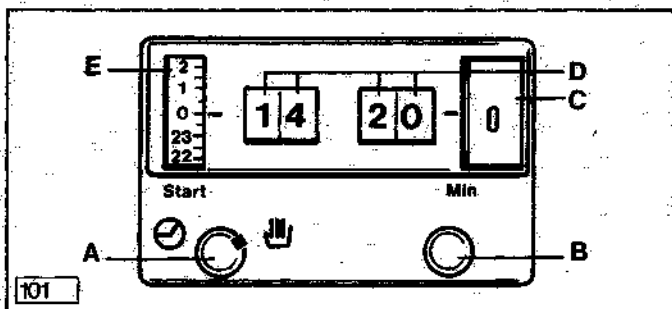

- Select the cooking method and temperature as required.
- Set change-over switch A to the automatic symbol .
- Press knob B and hold it depressed until the required cooking time shows next to the marker in display C.

The oven immediately switches on and automatically off after the elapsed duration.

**At the end, an audible signal sounds for around two minutes. You can prematurely cancel it by pressing button B until "0" is next to the marker in display C.**

**Return the change-over switch A to the hand symbol  and turn the oven control knobs to the off position. The oven is ready to operate manually again.**

- Select the cooking method and temperature as required.
- Set change-over switch A to the automatic symbol .
- Press knob B and hold it depressed until the required cooking time shows against the marker in display C.
- Press change-over switch A and hold it depressed until the required start time shows against the marker in display E.

The oven switches on automatically at the correct time and then switches off automatically at the cooking end.

**At the end, an audible signal sounds for around two minutes. You can prematurely cancel it by pressing button B until "0" shows against the marker in display C.**

**Return the change-over switch A to face the hand symbol  and return the oven control knobs to the off position.**

**The oven is ready to operate manually again.**



# Oven

Before using for the first time, refer to the section describing pre-cleaning of the oven.

The **oven** is a multi-function oven which features hot air cooking, Rotitherm roasting/grilling and traditional grilling. For further details consult the relevant sections in this booklet.

The shelf positions feature 6 (4) levels, the cooking tables supplied recommend the shelf position on which the oven will produce best results.

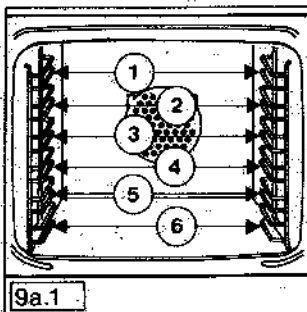



## General

## Shelf levels

## Fat filter

The fat filter supplied protects the fan against soiling. **It must always be in place when:**

- **Meat is cooked in uncovered containers using the hot air mode**  (do not insert when baking!);
- **During Rotitherm roasting/grilling**  (on multi-function ovens only) or traditional grilling.

How to insert the fat filter:

Hold the fat filter by the handle and insert the two tabs (see illustrations) into the slots in the back panel of the oven thereby covering the fan opening.

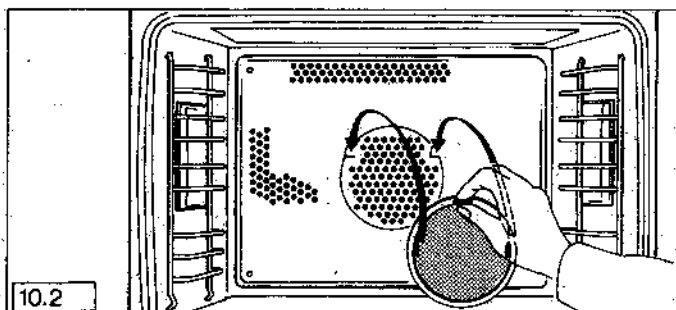

The fat filter must cover the opening completely.

Cleaning the fat filter:

**To clean the oven all oven controls must be set to the off position.** The fat filter should be cleaned after every use. To remove the fat filter hold it by the handle and pull upwards.

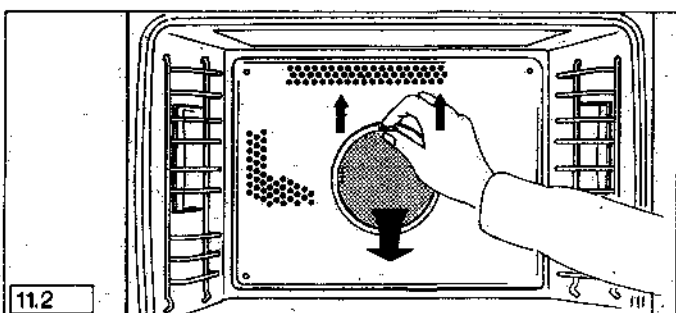

How to clean the filter, see "Cleaning the fat filter" in this booklet. The fat filter must only be clipped into the oven when it is **totally dry**.

## Using the oven

Decide which cooking method you want to use and select the appropriate symbol on the cooking method selector, e. g.,  for Hot Air. Then select the required temperature with the temperature control. The red thermostat light is on for as long as the oven is pre-heating. The thermostat light cycles on and off during operation, indicating heating periods.

When pre-heating the oven (see information in the relevant cooking charts) position food in the oven after the red thermostat light has gone out for the first time. To utilise the residual heat in the oven switch the oven off 5-10 minutes before the end of the cooking time by returning both the cooking method selector and the temperature control to the off positions.

### ■ Recommendations

When you use the hot air cooking system you can cook on several levels simultaneously. This saves time, is convenient and energy efficient. You can also cook different cakes at the same time for instance a Victoria Sandwich and a Bakewell Tart or a Madeira Cake with a Dundee Cake. Simply make sure that the cooking temperatures are roughly the same and that sufficient space is left between the shelves to allow the air to circulate freely.

If baking cakes with a high moisture content such as several apple pies, it may be advisable to use only 2 shelves at the same time to prevent too much steam forming in the oven.

### ■ Baking times and temperatures

When baking with hot air it is often unnecessary to pre-heat the oven. For exceptions see enclosed baking charts.

If you use the oven for batch baking, choose cakes which require similar temperatures. Different cooking times can be overcome by either placing cakes into the oven later or by removing them earlier.

The baking chart is provided as a quick reference to keep near the oven.

When baking on more than one level the time given in the cooking charts has to be extended by 10-20 minutes.

## Switching on and off

### With hot air



## ■ Baking on one or more levels

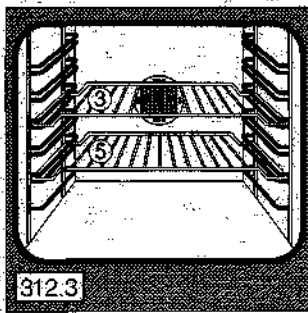
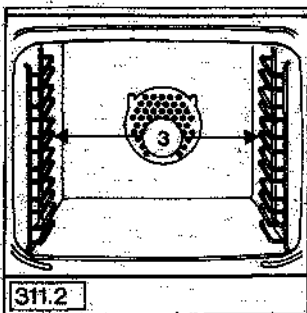

You can bake on several levels simultaneously. Place cake tins centrally on the wire shelves to ensure even cooking results. Full width baking sheets and additional wire shelves are available as optional extras - see section "Optional Extras" in this booklet.

## Roasting, Rotitherm roasting/ grilling and stewing in the oven

### Cooking method

- Choose the most suitable cooking method from the two options:

Hot air



Rotitherm roasting/grilling



Where the attached cooking charts highlight shelf positions and temperatures in bold print the oven may give you the better result when using this cooking method. However you may wish to experiment and decide for yourself which cooking method gives the best result.

A note to Rotitherm roasting/grilling as this is a relatively new method of cooking meat and poultry although spit-roasting which Rotitherm is replacing is not so new. Rotitherm is very much more convenient to use than a spit and once you have tried it you will be delighted with the results.

### ■ Recommendations

Wipe and weigh the meat. If stuffing is used, weigh the stuffed joint to calculate the cooking time. Place the joint in a suitable roasting dish, season with salt and pepper and brush lean joints with melted fat.

When cooking pies, place dish on a baking sheet to avoid spillage on to the floor of the oven.

## **Cooking temperatures and times**

- The times and temperatures given in the roasting chart provide a guide when cooking meat. Some adjustments may be necessary depending on the type of meat to be cooked. Cooking times have been given for meat which is at room temperature.
- Prime cuts can be cooked at higher temperatures than those which require a longer cooking time to tenderise the meat. A thick joint will require longer to cook through than a thinner one.
- A boned rolled joint will require a longer cooking time than one with the bone left in as bone is a conductor of heat.
- A small joint will require longer cooking time per 450 g (1 lb) than a large one. Allow an extra 30 minutes cooking time for joints up to and including 1.5 kg (3 lb).
- If the joint is cooked in foil the temperature has to be increased by 10 °C. To brown the joint, remove foil for the last 15 minutes or so of the cooking time.
- If cooking from frozen, place joint in a covered container and extend the calculated cooking time by approximately one third. To brown and crisp meat remove cover for the last 30 minutes of the cooking period.

## Ovenware

Never use stainless steel ovenware in the oven, since it reflects the heat. Meat, poultry, and fish should be cooked in ovenproof dishes or in the meat pan for large quantities.

Choose a dish which is just a little larger than the joint itself. This will contain any fat in a smaller area and reduce splashing. If you wish to roast potatoes in the same dish around the joint rather than in a separate one you need to make allowances for this when selecting a suitable dish.

Never place cooking containers on the base of the oven, but on the wire shelf which you should insert on the 4th or 5th level from the top depending on the size of the food to be cooked.

When using the Rotitherm roasting/grilling method (where featured) place the joint on the wire shelf 3rd and 4th from the top (depending on size of roast) and slot the drip-pan into the 5th or 6th from the top to catch the juices. If you want to roast potatoes in the dripping, allow approximately 1-1¼ hours cooking time.

Turn the roast over halfway through cooking to ensure an all round crisp and brown joint.

### **Warning!**

The handle must be removed whilst grilling. Failing to do so will result in overheating of the handle. This may cause damage leading to breakage of the handle.

### **Inserting the handle**

Lock it into the grip at the front of the pan. See illustration.

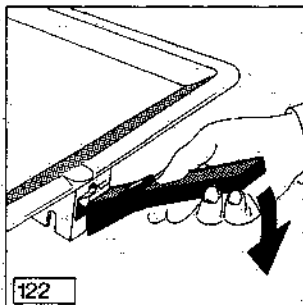

**Make sure that the handle is firmly attached to the pan!**

### **Removing the handle**

Press the button on the handle. See illustration.

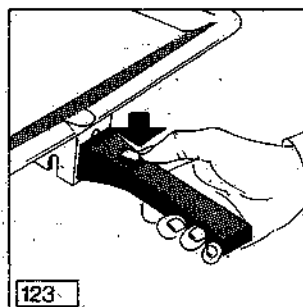

## Traditional grilling





and

### How to use the grill

Prime cuts of meat such as steaks and chops or fish, weighing less than 1 kg can either be fried or grilled. Salt large pieces shortly before grilling and small ones just after grilling.

Turn meat/fish after half the grilling time so that both sides are uniformly browned. Turn thin pieces once; thicker pieces need turning more often.

On appliances with a dual circuit grill , you should set the grill to grill symbol  for small amounts and to symbol  for larger amounts.

Select the highest setting on the variable temperature selector to seal the food and then turn down to a lower temperature. Position the wire shelf with the projection facing upwards or downwards in a shelf position of your choice depending on the thickness of the food you wish to grill.

Place the grill pan on the wire shelf and remove the grill pan handle.

### The oven door is closed during grilling

There is no need to pre-heat the grill unless you prefer to do so.

Grill pan and wire shelf can be cleaned more easily if soaked in the sink with water and washing-up liquid after grilling.



## Menu cooking in the oven

- The hot air oven is extremely versatile since you can cook a complete meal in it. You can cook different foods at the same time, such as fish and cakes, without any transfer of smell or taste from one to the other.
- When menu cooking try to choose foods which require similar cooking temperatures.
- When cooking meat in uncovered containers the **fat filter** must be inserted.  
When cooking pies or cakes at the same time as a roast you can choose pies or cakes which normally cook at temperatures 20 °C lower than the roast. Temperature differences of 10 °C lower than the roast can be compensated by longer or shorter cooking times.  
Shelf positions are chosen according to the food being cooked and in connection with the cooking guidelines in the recipe book supplied.

### Menu suggestion:

Meat Loaf  
Potato Bake  
Buttered Carrots  
Fruity Rice Pudding

### Ovenware:

Oblong ovenproof dishes

### Shelf positions:

Meat Loaf & Potato Bake  
Side by side 3rd from top  
Carrots and Fruity Rice Pudding  
Side by side 5th from top

### Cooking method:

Hot Air

### Temperature:

170–180 °C

### Time:

Approx. 60–75 minutes

**Defrosting  
by hot air**



**in the oven**

- Food in flat aluminium containers defrosts especially well since aluminium is a good heat conductor. For freezing and subsequent defrosting of meat and vegetable dishes, flat aluminium containers should therefore be used. For defrosting uncooked frozen meat and fruit, closed ovenproof dishes are especially well suited.

Position the containers on the wire shelf or in the meat pan 4th from the top.

Food	Temp. °C	Time - Hours/minutes	
Ready-made meals 1-4 portions)	200	0.40-0.50	thawing and heating ready to serve
Small cakes without cream fillings or top- pings (in foil)	200	0.15-0.20	ready to serve
Large cakes without cream fillings or top- pings (in foil)	200	0.30-0.45	ready to serve
Un sliced bread in foil (approx. 450 g/1 lb)	200	0.15 + 0.30 at room temp.	ready to serve
Bread rolls	200	0.15 + 0.30 at room temp.	ready to serve
Fruit, e. g. 300 g strawberries, raspber- ries (in covered con- tainer)	200	0.15 + 0.15 at room temp.	ready to serve
Ready to cook foods (pizza, pies)	200	0.45-1.00	ready to serve
Uncooked joints (e. g. 1.5 kg)	180-200	2.00-3.00 depending on type of meat	thawed and cooked
Chicken approx. 1 kg (cover with greaseproof paper)	50	1.00-1.15	thawed; remove giblets and roast

## Bottling in the oven

- For bottling, use only jars with rubber seals and glass lids. Never use jars with screw fittings or bayonet catches or metal tins. And make sure you use fresh foodstuffs!

The oven holds 6 bottling jars of 1–1.5 litres capacity.

Place 1 cup of hot water in the drip-pan so that the necessary humidity is retained in the oven.

- Position the jars in the enamelled pan on the 4th level from the top. The jars should not touch, must wherever possible be filled to the same level with the same contents and must be securely clamped.
- To **switch on**, turn the cooking method selector to hot air  and the oven temperature control to 160 °C.
- **Keep an eye** on the food being bottled.

As soon as the liquid in the first jars (when bottling **fruit** or **gherkins**) **begins** to bubble (after around 45 minutes for 1 litre jars) switch off the oven, but allow the jars to stand a further 30 minutes or so – around 15 minutes for soft fruit, e. g. strawberries – in the closed oven.

When bottling **vegetables** or **meat**, set back the oven temperature control to 100 °C as soon as the liquid in the first jars **begins** to bubble and allow the contents to **cook** for a further 60–90 minutes. Then switch off the oven and allow the jars to stand a further 30 minutes in the closed oven.

## Cleaning and care

### Ovens

These instructions refer to a large range of AEG double and single ovens.

### Secondary Oven

- All secondary ovens have a catalytic roof panel as standard. Some models have a complete catalytic set provided as standard. For those models which do not have it as standard it is available as an optional extra.

### Main Oven

- The main oven has catalytic roof (except Vitratherm ceramic roof models), sides and back panels, either as standard or they are available as optional extras from your AEG retailer depending on the model you selected to buy (except ovens which include microwave). If your main oven has a pyrolytic self-cleaning system, then also consult the relevant pages for cleaning the oven.

### Before cleaning the ovens

Allow the ovens to cool down if they have been used before cleaning. Switch off the ovens before cleaning.

### Cleaning

Ovens which are cleaned after every use need very little attention. If left and used again fat splashes will bake on and are then difficult to remove.

Clean **glass surfaces, trims and controls** with a soft cloth and lukewarm water. Polish dry with a soft cloth.

The ceramic glass oven roof (Vitratherm - where featured) can be cleaned with an oven spray or with "Ovenpad" or "Kleenoff".

**Vitreous enamel** interior surfaces can be cleaned with:

- a damp cloth and mild detergent
- cream cleaners such as "Jif" and a cloth.
- oven cleaners such as "Ovenpad" or "Kleenoff". Do follow the manufacturer's instruction on the cleaning materials you use carefully.

Take care that oven cleaners do not come in contact with the fan or any other part of the oven other than the vitreous enamel.

**Do not use scouring pads or abrasive powder which may scratch the surface of any part of the appliance.**

### Catalytic liners

**Do not use any detergents, abrasives or oven cleaners on catalytic liners.**

### Secondary oven

It should not normally be necessary to clean the catalytic roof in water. If you feel you would like to do so, take out the roof and wash in warm, soapy water, followed by rinsing in clear water.

If your oven has a catalytic roof, sides and back panel either as standard equipment or if you have bought these parts separately and fitted them, then the following information will be of interest to you:

The liners help to keep the oven cleaner as they clean themselves to a great extent during roasting and baking at temperatures above 200 °C. As cleaning may be improved by exposure to a higher temperature it may be necessary to run the oven at 250 °C for 1 or 2 hours per week. Before carrying out such a heat cycle, remove all oven equipment and make sure that you have cleaned the unlined surfaces to prevent any soil from baking on. For isolated stubborn stains use a soft brush and very hot soapy water. Never use abrasive cleaners or scouring powders.

**Warning! Isolate the oven from supply before replacing the oven lamp.**

To clean the glass cover or change the oven lamp the glass cover can be taken off by turning it anti-clockwise:

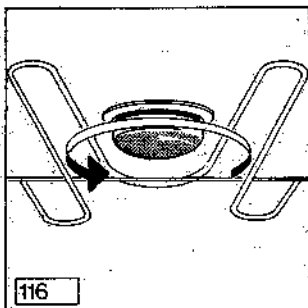

You can **illuminate** the oven for cleaning. To do this, turn the oven control knob or the cooking method selector to the lamp position .

■ **Thorough cleaning**

For thorough cleaning, you can remove various parts:

**Main oven**

**Cleaning the lamp cover or replacing the oven lamp**

**Oven lighting**

## Removing the oven door (main and/or secondary ovens)

- Removing the oven door  
Fully open the oven door.
  1. Pull the door catch on both door hinges towards you (see illustration).
  2. Lift the door up and pull forward away from the oven (**grip the sides – do not pull on the door handle!**).

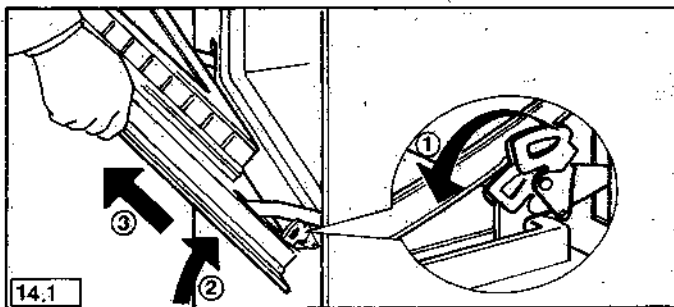

- Replacing the oven door
  1. Insert both brackets into the oven frame.
  2. Fully open the door and return door catches to their working positions (see illustration).

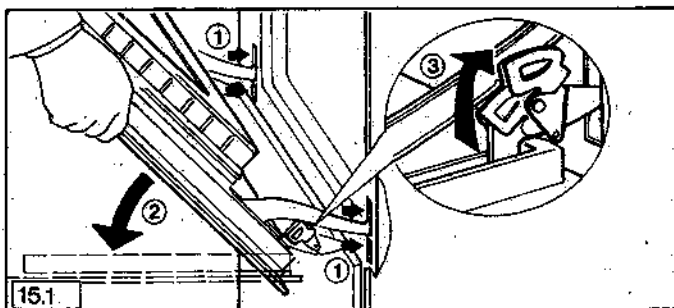

■ Shelf supports

To clean the sides of the oven, the shelf supports (see illustration) can be removed.

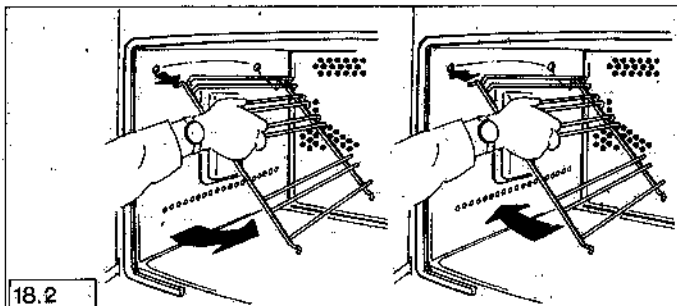

Pull the shelf support at the bottom, towards the centre of the oven and unhook from the top. Replace in reverse order.

**Fold down grill/top heating element in the main oven.**

The grill/top heating element can be folded down to facilitate occasional cleaning of the oven roof.

**Warning! Before you proceed ensure that the element is cold and all the oven controls are switched off.**

Turn the 2 holding screws to the centre. The element folds down giving you access to the oven roof (see illustration)

**Warning! Do not force the element too far down otherwise you run the risk that it breaks off.**

After cleaning, push the element upward and turn the hooks back ensuring that the **crossbar of the element** is secured within the hooks.

**The hooks must not be clipped over the element.**

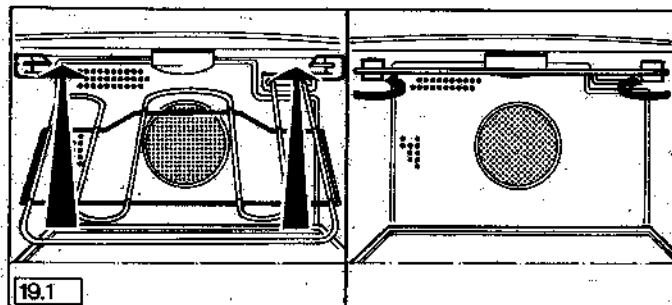

**Removing the shelf supports**

**Cleaning  
the fat  
filter**

The fat filter should be cleaned after every use. To remove filter, hold it by the handle and lift upwards. Place the fat filter in a saucepan, add approximately 1 tbsp. of automatic washing powder or 1 tsp. of dishwasher powder and cover filter with water. Bring to the boil and leave to soak for approx. 30 mins. or longer depending on the degree of soiling. Make sure the solution does not boil over as it could mark your hob. Rinse filter in clear water and dry. For light soilage wash in a 65 °C dishwasher programme.



## Optional extras

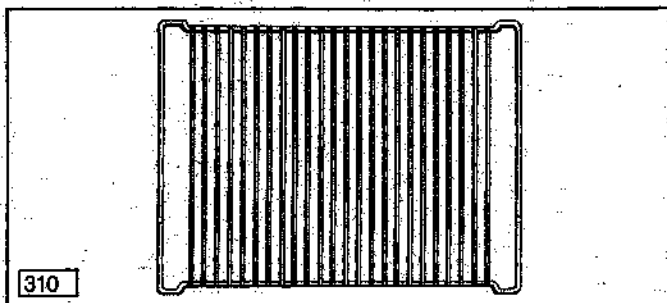

Additional wire shelf  
ET No. 661 307 541

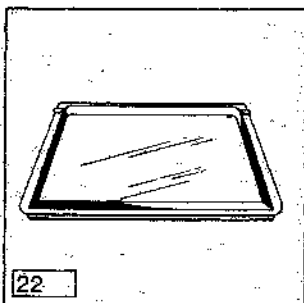

Baking sheet  
E No. 611 898 620

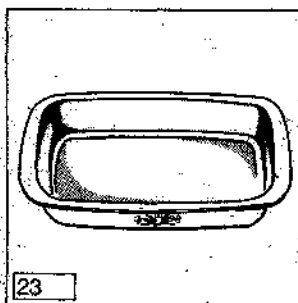

Ceramic oven dish  
E No. 611 899 660

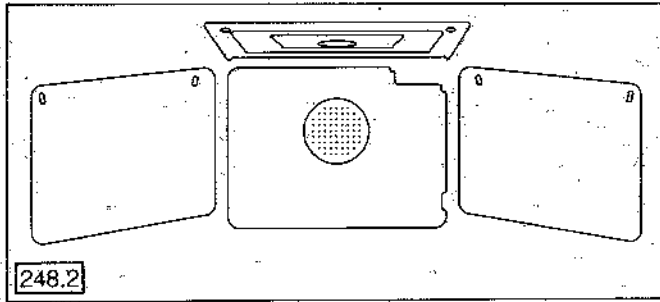

Catalytic set KTU  
E No. 611 898 610

## What to do if ... (something goes wrong?)

... the pilot lamps do not show?

... the oven does not heat?

1. You may well have not operated all relevant switches or
2. The fuse in the fuse box has blown.
3. **IMPORTANT** – Make sure that the oven door is closed completely.

... the fuses keep blowing?

Please call an approved and qualified electrician.

... the oven lamp fails?

See **Cleaning and care** on page 21.

Replacement lamps are not covered by warranty and are not free of charge.

... the oven cannot be switched on?

Check whether:

- ... you forgot to turn the change-over switch on the automatic timer back to the manual symbol  after time controlled cooking.

**Please make sure that you are not able to rectify the fault yourself prior to calling a service engineer in connection with one of the aforementioned problems, as the cost involved will have to be passed on even during the warranty period.**

**Therefore, follow the instructions in this booklet and any additional information which may accompany this appliance carefully.**

**AEG electrical appliances comply with current safety regulations. Repairs to these appliances should only be carried out by qualified AEG engineers or AEG appointed service agents. Repairs carried out by unauthorised personnel could lead to considerable damage and could pose a considerable safety hazard to the user.**

**Faults you  
can rectify  
yourself**

## Service

Should you be unable to locate the cause of the problem in spite of the above check-list please contact your **AEG** service department quoting the **E** and **F** numbers which you will find on the rating plate (see illustration/arrow).

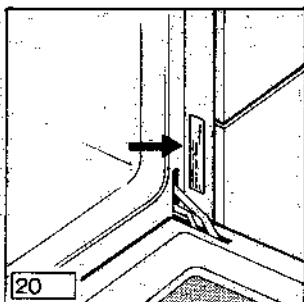

Please transfer these numbers to the space provided below for your convenience.

These numbers enable the service department to prepare as far as possible any spare parts required to rectify the fault on first call. This may save you money.

**E-No.** .....

**F-No.** .....

### AEG Service Locations In the United Kingdom

#### AEG UK Limited

##### Head Office

217 Bath Road  
Slough, Berks. SL1 4AW  
Tel.: 0753 872506  
Telex: 847541  
Telefax: 0753 512271

#### AEG Northern Service Centre

Unit 20, Haigh Park  
Haigh Avenue  
Stockport  
Gt. Manchester SK4 1QR  
Tel.: 061 487 2205  
Telefax: 061 474 1191

#### AEG Scottish Service Centre

Block 11, Unit 1  
Dundyvan Industrial Estate  
Coatbridge  
Lanarkshire ML5 4AQ  
Tel.: 0236 440387  
Telefax: 0236 440256

#### Service Appointments

Bristol (call diverted to Slough) 0272 252880  
Norfolk (call diverted to Slough) 0603 765515

# AEG

**AUS  
ERFAHRUNG  
GUT**

AEG Hausgeräte AG  
Postfach 1036  
D-8500 Nürnberg 1

© Copyright by AEG

H 260 253 240 - 03931/03 -